

Hashira Wall Lamp

by Norm Architects

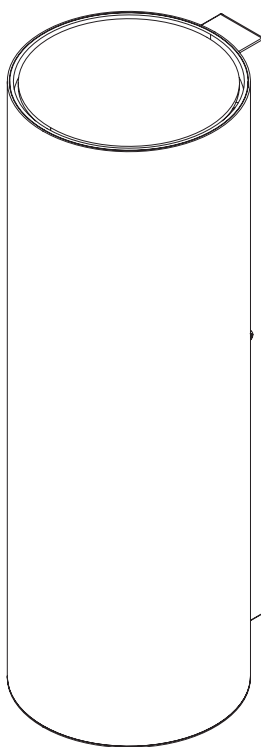

MENU

Congratulations with your new HashiraWall Lamp designed by Norm Architects. We hope you will enjoy using it. Please follow these instructions carefully to ensure the safe and correct installation of your new lamp.

COMPONENT OVERVIEW



1 x Wall lamp



1 x Wall Plaque (optional)

TOOLS NEEDED

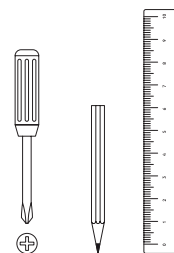

TECHNICAL SPECIFICATIONS

THE LAMP RANGE IS TESTED ACCORDING TO
UL 1598:2018 Ed.4
CSA C22.2#250.0:2018 Ed.4

LIGHTSOURCE DETAILS:

LED PC board
Watt: 4 W
Lumen output: 380 Lm
Lumen efficiency: 95 Lm / W
Color temperature: 2700-2800 K
CRI: > 80
Energetic class: F

NOT DIMMABLE

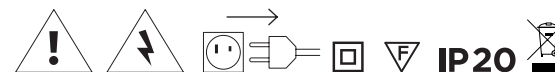

CARE INSTRUCTIONS

Remove the plug from the mains before cleaning. Wipe clean with a soft, dry cloth. Do not use chemical cleaners, solvents or abrasives.

Please check the specific rules for electrical installation work in your country. Some countries may require an authorised electrical contractor.

NOTE

Contact a qualified electrician if you experience any issues during installation. The external cable cannot be replaced. If damaged, it must be replaced only by the manufacturer, their service agent or another qualified individual.

WARNING

Improper installation, adjustment, alteration, service, maintenance or use can cause personal injury or property damage.

Before installing, always turn off the power for the circuit.

CAUTION

Keep this product and its packaging out of children's reach.

DISPOSAL

At the end of its life, dispose of this lamp in the correct waste bin or at a recycling station. Do not discard as household waste. Your local authority can provide further information on where and how it can be disposed of.

The EU Waste from Electrical and Electronic Equipment (WEEE) Directive 2005 encourages the recycling of this item.

IMPORTANT INFORMATION

Due to the diversity of (partition) walls, we are unable to offer fixings. To determine which is suitable for your space, you will first need to identify the type of wall onto which you will attach this product. Below are recommended fixings.

BLIND WALLS

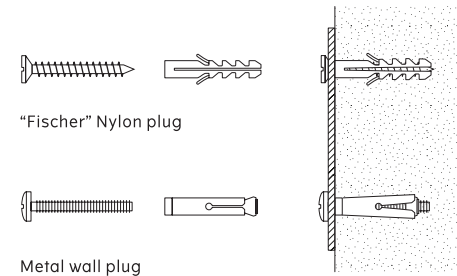

"Fischer" Nylon plug

Metal wall plug

STUDDED WALLS

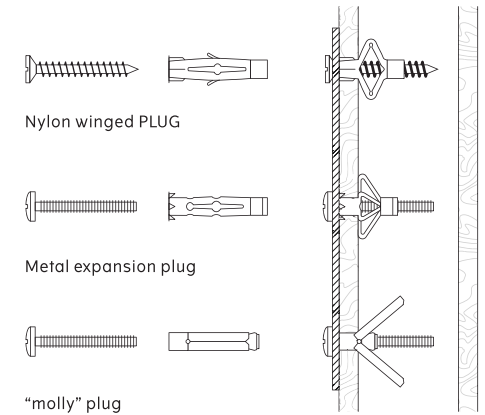

Nylon winged PLUG

Metal expansion plug

"molly" plug

DRILL

Use a drill bit that is compatible in size with the hardware used and the type of wall.

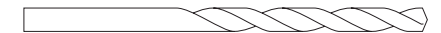

For instructions on how to change the bulb, see page 10.

1

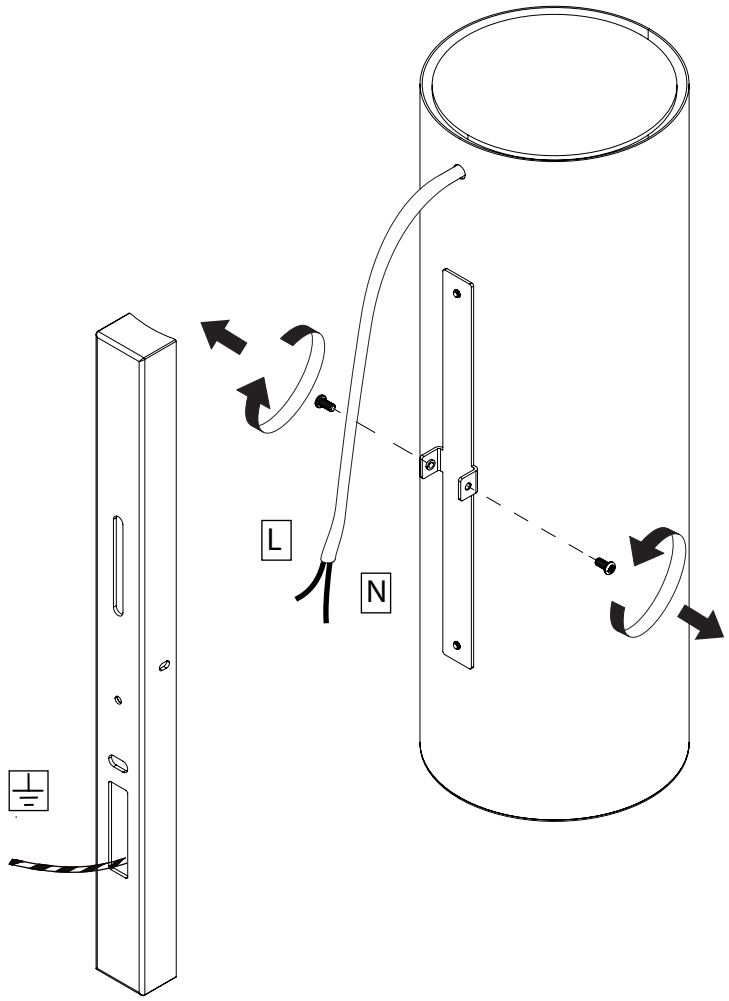

2

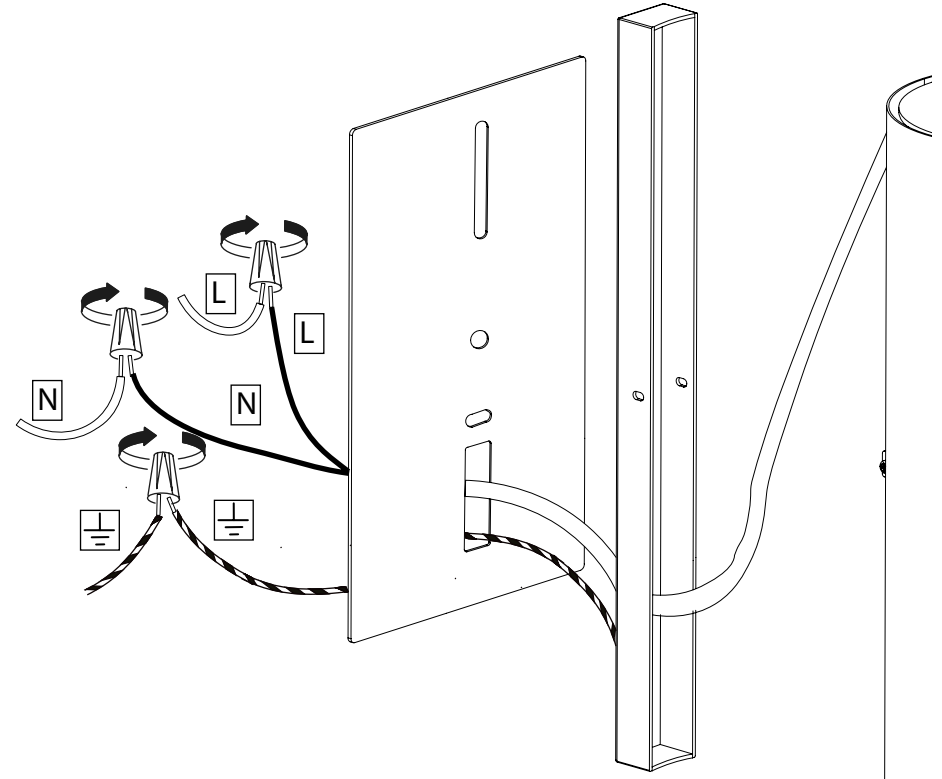

3

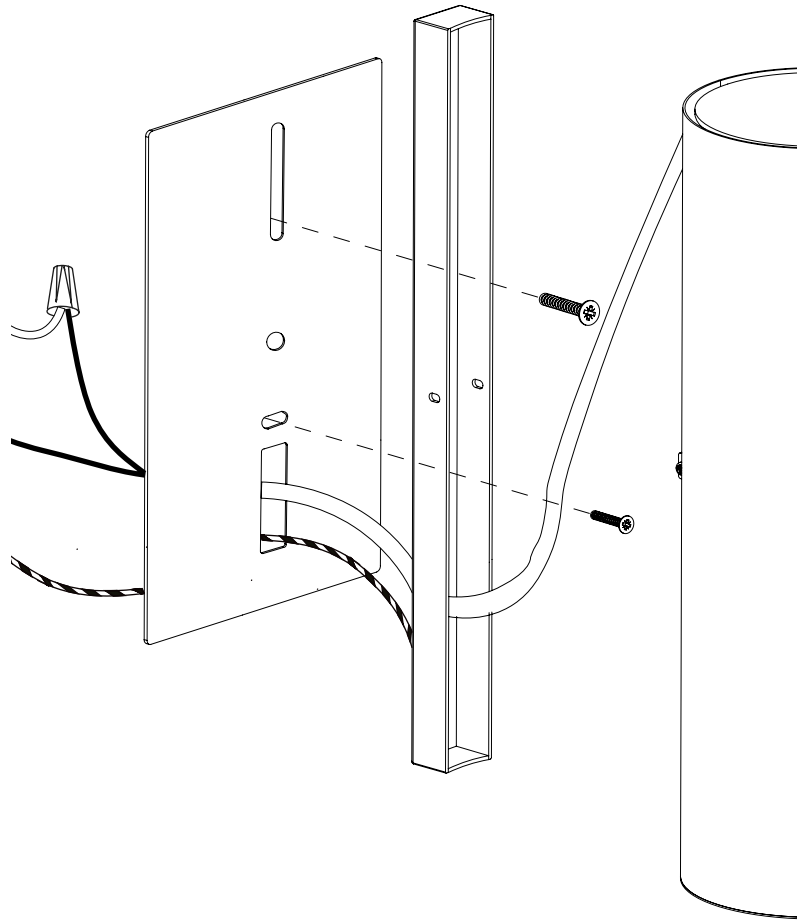

4

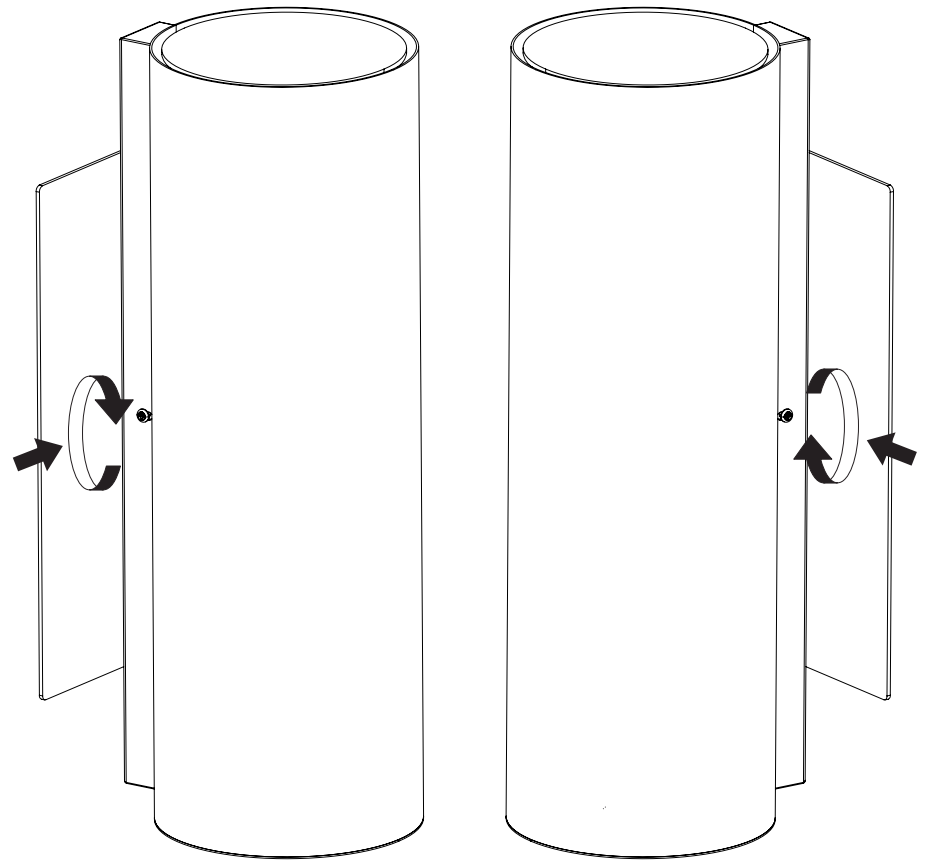

1

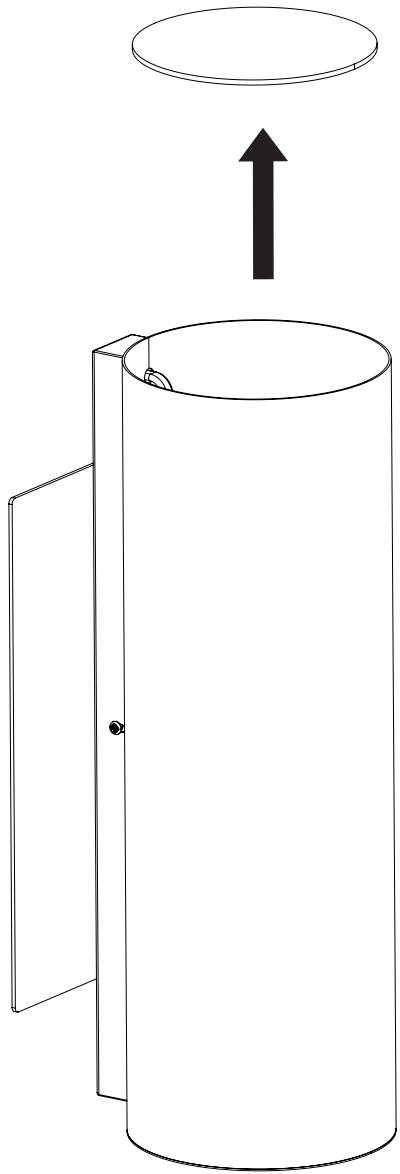

2

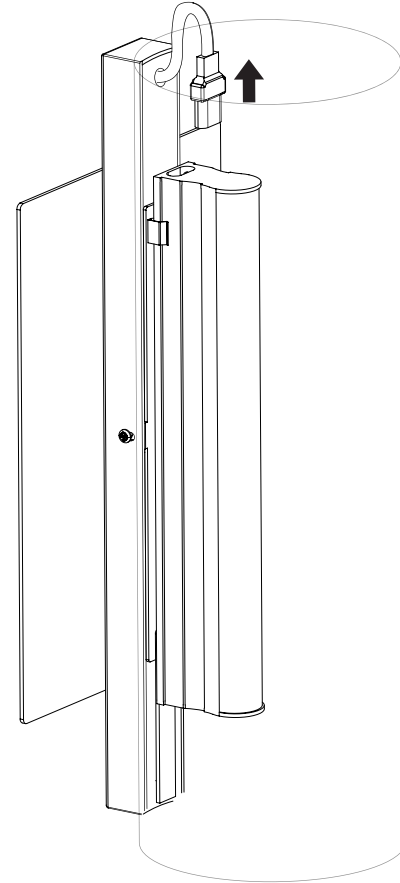

3

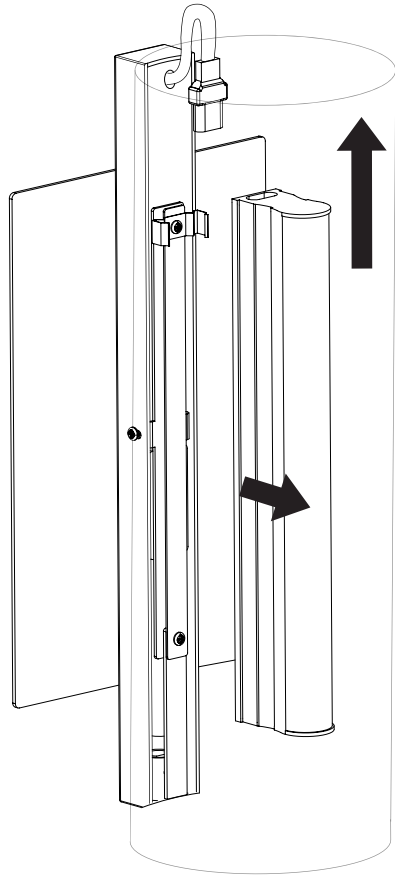

4

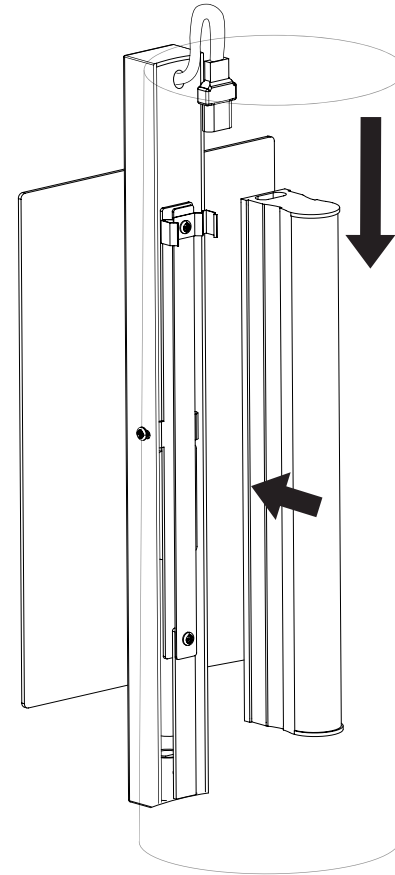

5

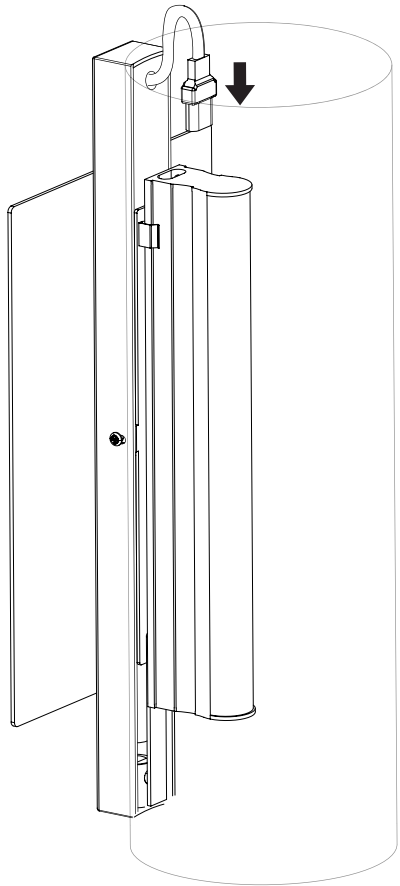

6

